



Société Nationale de
Certification et d'Homologation
Société à responsabilité limitée









October 14th, 2010

STATEMENT

We confirm, that the following replacement silencer type 4588, produced by SITO Gruppo Industriale S.p.A. (S.G.I.), is complying with

- the EC-Directive 97/24/EC Chapter 9 regarding permissible sound level and exhaust system

An EC type approval number has been granted by the luxembourgian Ministry for Sustainable Development and Infrastructure, department of Transport, for the following version of the above mentioned replacement silencer type:

Silencer Version	Drawing No.	Type approval number	Vehicle type	Vehicle Model
4564	4566	SGI  0459 	ZJM41 – 2JM41 – 46 – 46000046	MALAGUTI F12 Phantom (Liquid cooled)
4564	4566	SGI  0459 	ZJM40/D – 2JM40 – 46 – 46000046	MALAGUTI F12 Phantom (Air cooled)
4564	4566	SGI  0459 	ZJM4600000 – ZJM46 – 46	MALAGUTI F12 Phantom kat (Air cooled)
4564	4566	SGI  0459 	47/K1/02 – ZJM47 – ZJM4700000 – 47 – ZJM47	MALAGUTI F12 Phantom kat (Liquid cooled)



Gilles AST
Expert Technique

Adresse:
BP 23
L-5201 Sandweiler

Siège social:
11, route de Luxembourg
L-5230 Sandweiler

Capital social: 3.500.000 €
R.C. B 27180
N° TVA: LU 13770825

Tél.: (+352) 35 72 14 - 250
Fax: (+352) 35 72 14 - 244
E-mail: info@snch.lu
Home page: www.snch.lu



9933320

Solo per - only for - Seulement pour
- Nur für - Sólo para:
F12 Air/Liquid

Solo per - only for - Seulement pour
- Nur für - Sólo para:
F12 Kat

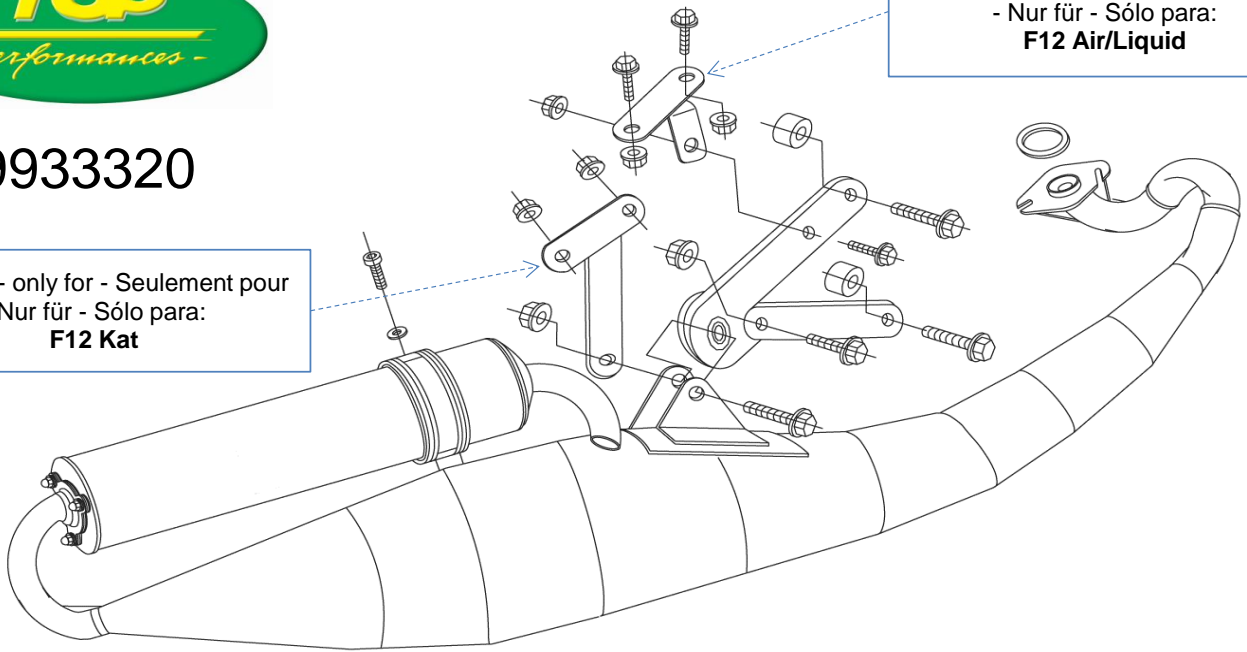

RULLI E MOLLE - ROLLERS AND SPRINGS - MASSELOTES ET RESSORTS - ROLLEN UND FEDERN - RODILLOS Y MUELLES

RULLI: (art. 4645 – gr 4,7 per la versione ad aria e art. 4645 - gr. 5,0 per la versione ad acqua e F12 KAT)

MOLLE: (MINARELLI HARD GIALLE)

ROLLERS: (art 4645 – 4,7 g. for the air-cooled version, or art 4645 – 5,0 g. for the water-cooled version and F12 KATA) - **SPRINGS:** (MINARELLI HARD YELLOW)

MASSELOTES: (ref. 4645 - 4,7 grammes pour la version "air" ou ref. 4645 - 5,0 grammes pour la version "liquide" et F12 KATA) - **RESSORTS:** (MINARELLI HARD JAUNES)

RODILLOS: (art. 4645 – gr. 4,7 para la versión de aire en el art. 4645 -gr. 5,0 para la versión de agua y F12 KATA)

MUELLES: (MINARELLI HARD AMARILLO)

ROLLEN: (Art. 4645 - gr. 4,7 für die luftgekühlte Ausführung und Art. 4645 - gr. 5,0 für die wassergekühlte Ausführung und F12 KATA) - **FEDERN:** (MINARELLI HARD GELBE)

**DISEGNO TECNICO RULLI E MOLLE - TECHNICAL DRAWING ROLLERS AND SPRINGS
CROQUIS TECHNIQUE MASSELOTES ET RESSORTS - TECHNISCHE ZEICHNUNG ROLLEN UND FEDERN
DISEÑO TÉCNICO RODILLOS Y MUELLES**

FIGURA 1

- * Battuta rullo
- * Roller beat
- * Retour plastique
- * Anschlag der rolle
- * Batiante de rodillo



FIGURA 2

Senso di rotazione
Clock-wise rotation
Sens de rotation
Drehrichtung
Sentido de rotación

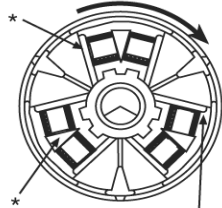

- * Battuta rullo
- * Roller beat
- * Retour plastique
- * Anschlag der rolle
- * Batiante de rodillo

MOLLE DA SOSTITUIRE - SPRINGS TO BE REPLACED
RESSORTS À REMPLACER - ZU ERSETZENDE FEDER
MUELLES PARA SUSTITUCIÓN

FIGURA 3

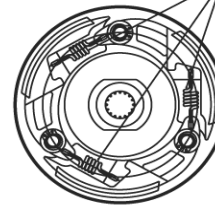

Frizione a 3 molle
3 springs clutch
Embrajage à 3 molle
3-feder-kupplung
Friccion con 3 muelles

FIGURA 4

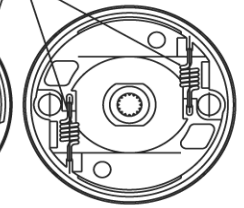

Frizione a 2 molle
2 springs clutch
Embrajage à 2 ressorts
2-feder-kupplung
Friccion con 2 muelles

VISTA DAL LATO INTERNO - VIEW FROM THE INNER SIDE
VUE DE L'INTÉRIEUR - ANSICHT VON INNENSEITE
VISTA DESDE EL LADO INTERIOR