



Société Nationale de
Certification et d'Homologation
Société à responsabilité limitée











October 14th, 2010

STATEMENT

We confirm, that the following replacement silencer type 4588, produced by SITO Gruppo Industriale S.p.A. (S.G.I.), is complying with

- the EC-Directive 97/24/EC Chapter 9 regarding permissible sound level and exhaust system

An EC type approval number has been granted by the luxembourgian Ministry for Sustainable Development and Infrastructure, department of Transport, for the following version of the above mentioned replacement silencer type:

Silencer Version	Drawing No.	Type approval number	Vehicle type	Vehicle Model
4572	4571	SGI  0459 	S1A	PEUGEOT BUXI M 50
4572	4571	SGI  0459 	S1AOKF	PEUGEOT METAL-X 50
4572	4571	SGI  0459 	S1A – VGAS1A01	PEUGEOT SQUAB 50
4572	4571	SGI  0459 	S1A-VGAS1A00	PEUGEOT TREKKER 50
4572	4571	SGI  0459 	S1C – S1C0KF – S1COKA – S1A – VGAS1CAAAA	PEUGEOT VIVACITY 50



Gilles AST
Expert Technique

Adresse:
BP 23
L-5201 Sandweiler

Siège social:
11, route de Luxembourg
L-5230 Sandweiler

Capital social: 3.500.000 €
R.C. B 27180
N° TVA: LU 13770825

Tél.: (+352) 35 72 14 - 250
Fax: (+352) 35 72 14 - 244
E-mail: info@snch.lu
Home page: www.snch.lu



9933350

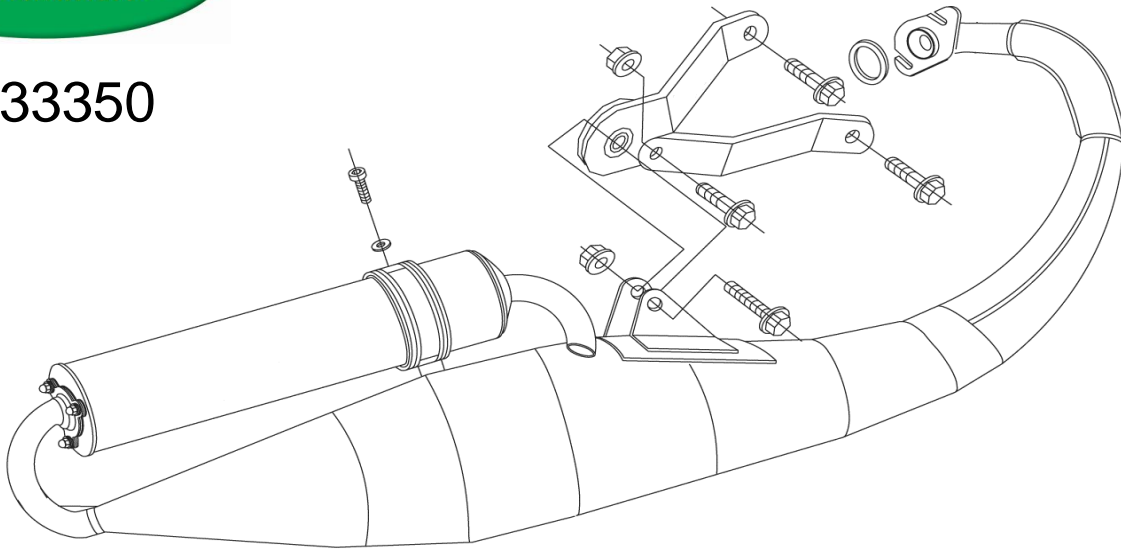

RULLI E MOLLE-ROLLERS AND SPRINGS-MASSELOTTES ET RESSORTS-ROLLEN UND FEDERN-RODILLOS Y MUELLES

Rulli: (art. 4646 – gr. 8,5 per PEUGEOT SQUAB - BUXI M) - (art. 4646 7,5 solo per PEUGEOT METAL-X 50)

Molle: (PIAGGIO MEDIUM ROSSE).

Rollers: (art 4646 – 8,5 g. - for PEUGEOT SQUAB - BUXI M) - (art. 4646 7,5 for PEUGEOT METAL-X 50)

Springs: (PIAGGIO MEDIUM RED).

Masselottes: (art. 4646 – gr. 8,5 pour PEUGEOT SQUAB - BUXI M) - (art. 4646 7,5 pour PEUGEOT METAL-X 50)

Ressorts: (PIAGGIO MEDIUM ROUGE).

Rodillos: (art. 4646 – gr. 8,5 para PEUGEOT SQUAB - BUXI M) - (art. 4646 7,5 para PEUGEOT METAL-X 50)

Muelles: (PIAGGIO MEDIUM ROJO).

Rollen: (art. 4646 – gr. 8,5 für PEUGEOT SQUAB - BUXI M) - (art. 4646 7,5 für PEUGEOT METAL-X 50)

Federn: (PIAGGIO MEDIUM ROT).

**DISEGNO TECNICO RULLI E MOLLE - TECHNICAL DRAWING ROLLERS AND SPRINGS
CROQUIS TECHNIQUE MASSELOTTES ET RESSORTS - TECHNISCHE ZEICHNUNG ROLLEN UND FEDERN
DISEÑO TÉCNICO RODILLOS Y MUELLES**

FIGURA 1

- * Battuta rullo
- * Roller beat
- * Retour plastique
- * Anschlag der rolle
- * Batiente de rodillo



FIGURA 2

Senso di rotazione
Clock-wise rotation
Sens de rotation
Drehrichtung
Sentido de rotación

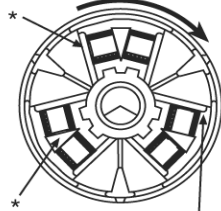

- * Battuta rullo
- * Roller beat
- * Retour plastique
- * Anschlag der rolle
- * Batiente de rodillo

MOLLE DA SOSTITUIRE - SPRINGS TO BE REPLACED
RESSORTS À REMPLACER - ZU ERSETZENDE FEDER
MUELLES PARA SUSTITUCIÓN

FIGURA 3

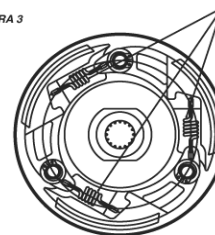

Frizione a 3 molle
3 springs clutch
Embrajage à 3 molle
3-feder-kupplung
Friccion con 3 muelles

FIGURA 4

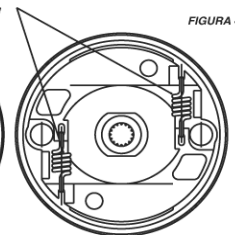

Frizione a 2 molle
2 springs clutch
Embrajage à 2 ressorts
2-feder-kupplung
Friccion con 2 muelles

VISTA DAL LATO INTERNO - VIEW FROM THE INNER SIDE
VUE DE L'INTÉRIEUR - ANSICHT VON INNENSEITE
VISTA DESDE EL LADO INTERIOR